

--

Date:
Client:
Project:



seaofwhite

Suite 4 | 22 King Edward Road
OSBORNE PARK WA 6017
T 08 9344 1500
W seaofwhite.com.au



4321

Build-in basin tap with on-off sensor for 'hands free' operation. For vertical mounting. Sensor aligned with wall. Valve box VR2617 included. 4321UP = Valve 4300, sensor cable VR509. 4321AP = 225 mm spout Ø20, sensor VR510, 60 mm circular flanges 001, VR512.

Ada approved.

Flow

	Bar:	1.0	2.0	3.0	4.0	5.0
4321	(l/min)	2.9	4.1	5.0	5.0	5.0
4321 ¹⁾	(l/min)	2.6	3.7	4.5	4.5	4.5
Areator VR16WS	(l/min)	1.1	1.6	1.9	1.9	1.9
Areator VR161J	(l/min)	2.3	3.3	4.0	4.0	4.0

¹⁾ USA standard

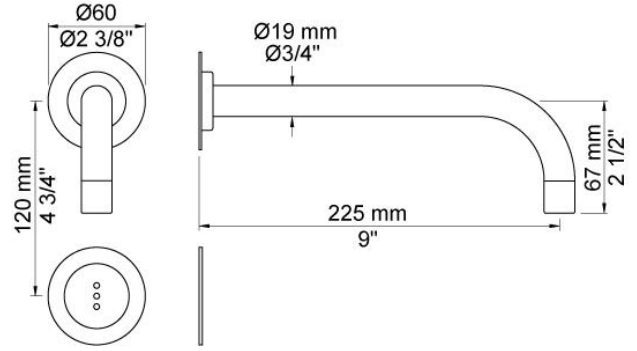

Available in colors

	Color 20, Brushed chrome
Color 02, Grey	Color 21, Carmine red
Color 04, Light blue	Color 25, Pink
Color 05, Orange	Color 27, Matt black
Color 06, Light green	Color 28, Matt white
Color 08, Yellow	Color 40, Brushed stainless steel
Color 09, Dark grey	Color 60, Black
Color 12, Mocca	Color 61, Brushed black
Color 14, Bright red	Color 63, Copper
Color 15, Dark blue	Color 64, Brushed Copper
Color 16, Polished chrome	Color 65, Gold
Color 17, Gloss black	Color 68, Nickel
Color 18, White	Color 70, Brushed Gold
Color 19, Natural brass	

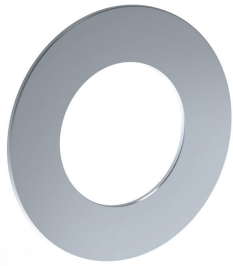

001
60 mm circular flange. Hole Ø30 mm.

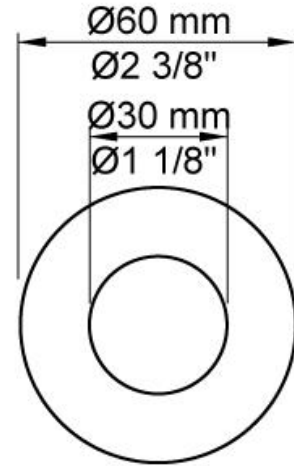

020
225 mm fixed spout with water saving aerator.

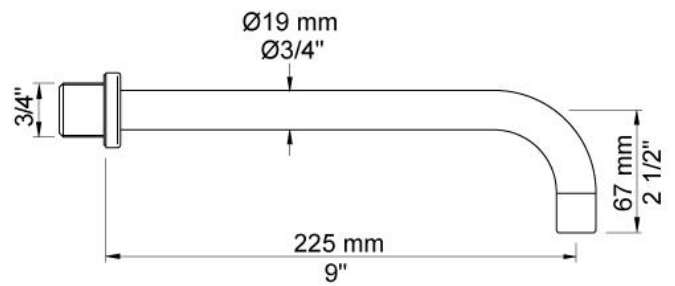

4300
Build-in valve with on-off sensor for 'hands free' operation for vertical installation.
Valve box for electronic mixer, VR2617 included.

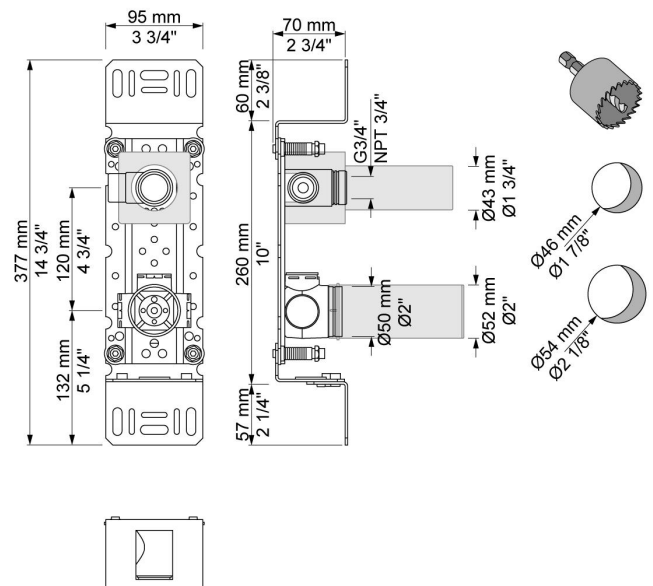



VR2617
Valve box.

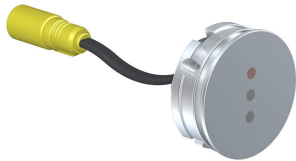
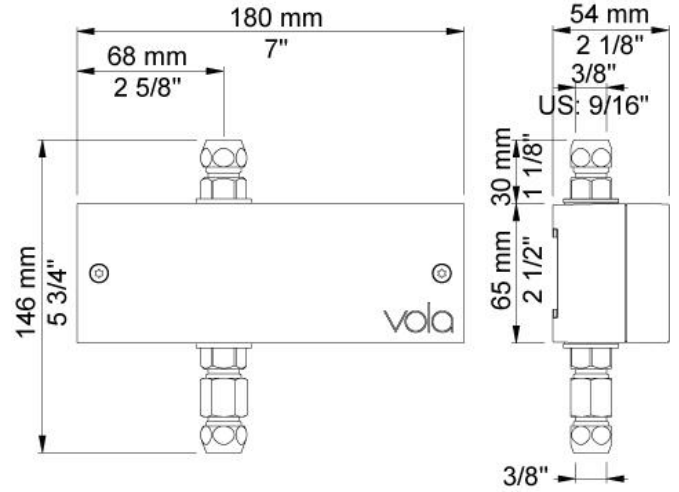

VR510
Sensor for electronic tap 4300, 4800 and 4900.

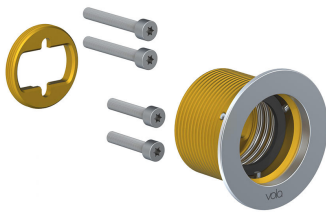
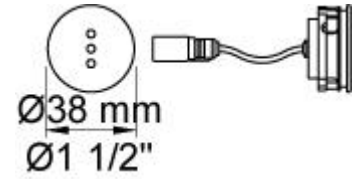

VR512
60 mm circular flange. Hole $\text{Ø}38 \text{ mm}$ for 4300, 4800 and 4900.

